

# A Robust Method of Vehicle Stability Accurate Measurement Using GPS and INS

Zhibin Miao<sup>1</sup>, Hongtian Zhang<sup>1</sup>, Jinzhu Zhang<sup>2</sup>

<sup>1</sup>College of Power and Energy, Harbin Engineering University, Harbin 150001, China, mzb@hrbeu.edu.cn; zhanghongtian@163.com

<sup>2</sup>Heilongjiang Institute of Technology, Harbin 150050, China, hgcqcx@126.com

With the development of the vehicle industry, controlling stability has become more and more important. Techniques of evaluating vehicle stability are in high demand. Integration of Global Positioning System (GPS) and Inertial Navigation System (INS) is a very practical method to get high-precision measurement data. Usually, the Kalman filter is used to fuse the data from GPS and INS. In this paper, a robust method is used to measure vehicle sideslip angle and yaw rate, which are two important parameters for vehicle stability. First, a four-wheel vehicle dynamic model is introduced, based on sideslip angle and yaw rate. Second, a double level Kalman filter is established to fuse the data from Global Positioning System and Inertial Navigation System. Then, this method is simulated on a sample vehicle, using Carsim software to test the sideslip angle and yaw rate. Finally, a real experiment is made to verify the advantage of this approach. The experimental results showed the merits of this method of measurement and estimation, and the approach can meet the design requirements of the vehicle stability controller.

**Keywords:** Vehicle stability, Kalman filter, data fusion, sideslip angle, GPS/INS.

## 1. INTRODUCTION

WITH THE DEVELOPMENT of vehicle technology and the improvement of road traffic, automobiles are going faster and faster. There is a gradual increase in the role of high-speed instability as a factor in all kinds of traffic accidents. Audi company statistics indicate that with traffic accidents involving vehicles at speeds of 80 km/h to 100 km/h, there was a loss of stability in 40 % of the cases [1]. When the vehicle speed exceeds 160 km/h, almost all accidents are related to vehicle instability. Related studies also indicate that in serious traffic accidents caused by the loss of stability control, 82 % of vehicles will travel 40 meters after the loss of control. A Toyota Corporation [2] study also points out that the reason for almost accidents caused by the loss of control involves the vehicle sideslip motion. Therefore, stability control for vehicles is proposed. Vehicle handling stability is improved by controlling vehicle yaw motion.

Vehicle sideslip angle and yaw rate are two important parameters for vehicle stability [3]. Vehicle sideslip angle is the angle between the longitudinal axes of the automobile body and the automobile speed direction. However, nowadays the sideslip angle cannot be measured directly. This is one of the biggest problems for the current development of vehicle stability control system. Therefore, it is the premise and key technology of vehicle dynamics stability control to measure accurately the actual vehicle sideslip angle and yaw rate [4]. Gyroscope can measure the yaw rate, but there is no suitable equipment for directly measuring the vehicle sideslip angle. Estimation methods are used to get the sideslip angle. These methods are usually combined with the use of the yaw rate gyroscope and lateral acceleration sensor. However, these sensors usually contain a bias and noise. In addition, a lateral accelerometer cannot provide a good identification of vehicle lateral acceleration and gravity component of acceleration [5]. The errors of these sensors will be accumulated and even divergent, when

the integral is applied. Therefore, errors affect the performance of vehicle stability control system. However, the application of GPS and INS (inertial navigation system, including the gyroscope and accelerometer) can directly measure the vehicle sideslip angle. GPS is Global Positioning System. DGPS (Differential Global Positioning System) is a kind of GPS attached to the normal differential correction signal, improving data precision to millimeter level after processing.

There is a strong complementary link between GPS and INS. GPS has some disadvantages. For example, a receiver antenna may be blocked temporarily or it may lose position data due to a signal interruption. INS can provide position; velocity and azimuth information without an external reference source, but the system has accumulated error. It cannot give high-accuracy positioning information for a long time because of gyroscope drift error. Errors of INS are mainly random drift errors which cannot be compensated. GPS has such advantages as high positioning accuracy and no accumulated error. The two kinds of system, used in combination, can compensate for their respective limitations and give full play to their strengths. GPS measurement is stable but the refresh rate (1~10 Hz) is relatively low. GPS/INS integrated navigation system is a kind of composite that has unique advantages in terms of autonomy and bandwidth frequency Kalman filter is commonly used to fuse GPS/INS data.

GPS/INS is a trend to measure vehicle movement stability in modern automobile technology. At present, GPS measurement has a low refresh data rate, and sometimes there are obstacles that prevent vehicles from accepting GPS information. Therefore, GPS and inertial sensor combination application is needed. There are Kalman federated filtering algorithms, D-S evidence theory, neural network, adaptive H filtering, and fuzzy logic in data fusion. But each algorithm has limitations. Therefore, more convenient and high precision data fusion algorithm is a meaningful problem.

2. RELATED WORK

In a vehicle stability measurement system, GPS can be used to detect performance. It can also be used as a sensor to provide real-time information for a vehicle dynamics stability control system. Now GPS has been applied in vehicle dynamics stability testing instruments, and the study of GPS/INS combination for the vehicle stability test remains a hot topic. There are some reports in this area.

In driving conditions, one of the key vehicle stability controls is the accurate measurement of automobile state parameters. This is also the premise and foundation for the stability control system to control the vehicle [6]. But some important vehicle state parameters either cannot be measured through common sensors, or measuring cost is too high. For example, a very important stability parameter for vehicle control is the sideslip angle, which is the angle between the direction of the longitudinal axis of the vehicle speed and the direction of the vehicle body. It directly affects the vehicle yaw moment which affects the stability of the automobile. But unfortunately, at present no common sensors can directly measure the vehicle sideslip angle and the tire sideslip angle. The incomplete information of vehicle stability control has caused great difficulties for the implementation and promotion of the vehicle active safety control system. Vehicle stability control system requires estimating parameters such as adhesion coefficient of the road, sideslip angle, and speed [7]. Vehicle sideslip angle estimation algorithms are a common integral method, such as the Kalman filtering method, fuzzy observer, Luenberger observer, sliding mode observer and nonlinear observer. Cho Y. [8] proposed a method which can estimate vehicle sideslip angle based on an extended Kalman filter. The vehicle speed estimation method is a comprehensive method considering maximum wheel speed and road slope. Solmaz S. [9] proposed a method of estimation based on rolling horizon vehicle speed. Road adhesion coefficient has been detected based on vehicle dynamics modeling and sensors. Jun L. [10] proposed a road friction coefficient estimation method based on an extended Kalman filter algorithm. Yang Fuguang [11] proposed real-time pavement adhesion coefficient estimation method based on the extended state observer.

In vehicle active safety, Deng-Yuan Huang proposed a feature-based vehicle flow analysis and measurement system for a real-time traffic surveillance system [12] and Jeng-Shyang Pan proposed a vision optical flow based vehicle forward collision warning system for intelligent vehicle highway applications [13]. The researchers make a wide scope in vehicle active safety research.

Since the beginning of the 21 st Century, researchers have been conducting research on the measuring stability of state parameters of automobile. Yu Ming [14] from Southeast University developed an automobile road five-wheel RTK tester based on GPS carrier phase RTK technology. The five-wheel tester can precisely measure vehicle motion parameters and evaluate the vehicle movement performance based on dynamic measurement. Xin Guan and his student [15] from Jilin University have studied GPS/INS integrated navigation algorithm for measuring vehicle state information.

GPS is used for vehicle stability performance testing. It can measure real-time vehicle stability parameters such as running track, distance, azimuth, sideslip angle, speed and acceleration. Differential GPS technology not only achieves the online dynamic testing motion-state parameters, but also brings the dynamic positioning precision to centimeter level. For example, vehicle motion measurement speed precision is up to 0.05 km/h, and sideslip angle accuracy is up to 0.15 degree for GPS and inertial navigation system of British Oxford Technical Solutions company. Zhang Sumin [16] used the inertia navigation system and GPS to estimate vehicle speed, vehicle sideslip angle, yaw rate and other status information. Kirstin L. Rock [17] from Stanford University compared GPS/INS and auto optics test system to verify the effectiveness of the GPS/INS to measure the vehicle sideslip angle and speed.

David M. Bevy [18] from Auburn University estimated three key vehicle parameters such as tire-slip ratio, sideslip angle, and tire sideslip angle based on the GPS speed measuring method. He integrated GPS speed sensor and high frequency inertial measurement unit (low update rate accelerometer), and provided an accurate estimation of vehicle state parameters. In Canada, Automobile Multi-Sensors Research Center at the University of Calgary [19] studied how to reduce the measurement errors and improve testing precision. They proposed a navigation system with a velocity update scheme that could predict and reduce the error accumulation when there was a loss in GPS signals. Ryu J. [20] from Stanford University proposed a method to estimate the key parameters of vehicle stability based on vehicle grade inertial sensors and GPS receiver. The method can improve estimation accuracy for vehicle state parameters under the influence of pitch and roll sensor bias errors.

3. MODELS OF VEHICLE TESTING

A. Dynamical model of vehicle

In order to reflect an automobile motion state, this paper establishes an eight degrees of freedom dynamic model which includes vehicle rotary motion, longitudinal motion, lateral motion, yaw motion, roll motion, four wheels rotary motion, steering wheel angle, and vehicle speed. It assumes that:

1. Automobile vertical and pitch motions are ignored;
2. Dynamic characteristics of four tires are the same;
3. The influence of air resistance is ignored;
4. The effect of sprung mass is ignored [21];

According to Fig.1., eight degrees of freedom dynamic equations are presented as follows:

Longitudinal movement:

$$\sum F_{xi} = m(\dot{v}_x - v_y \gamma) \tag{1}$$

$$\sum F_{xi} = (F_{x1} + F_{x2}) \cos \delta - (F_{y1} + F_{y2}) \sin \delta + F_{x3} + F_{x4} \tag{2}$$

Lateral movement:

$$\sum F_{yi} = m(\dot{v}_y + v_x \gamma) - m_s h_s \ddot{\phi} \tag{3}$$

$$\sum F_{yi} = (F_{y1} + F_{y2}) \cos \delta + (F_{x1} + F_{x2}) \sin \delta + F_{y3} + F_{y4} \quad (4)$$

Yaw movement:

$$I_z \dot{\gamma} + I_{xz} \ddot{\phi} = \sum M_z \quad (5)$$

$$\begin{aligned} \sum M_z = & l_f (F_{y1} + F_{y2}) \cos \delta - (F_{y3} + F_{y4}) \sin \delta + \frac{l_f}{2} (F_{y1} - F_{y2}) \sin \delta - \\ & \frac{l_f}{2} (F_{x1} - F_{x2}) \cos \delta + l_f (F_{x1} + F_{x2}) \sin \delta - \frac{l_r}{2} (F_{x3} - F_{x4}) \end{aligned} \quad (6)$$

Roll movement:

$$I_x \ddot{\phi} - m_s h_s (\dot{v}_y + v_x \dot{\gamma}) + I_{xz} \dot{\gamma} = \sum M_x \quad (7)$$

$$\sum M_x = -(k_{\phi f} + k_{\phi r}) \phi - (c_{\phi f} + c_{\phi r}) \dot{\phi} + m_s g h_s \sin \phi \quad (8)$$

Four wheels motion equation:

$$I_{wi} \dot{\omega}_{wi} = F_{xi} R_w - T_{bi} \quad (i = 1, 2, 3, 4) \quad (9)$$

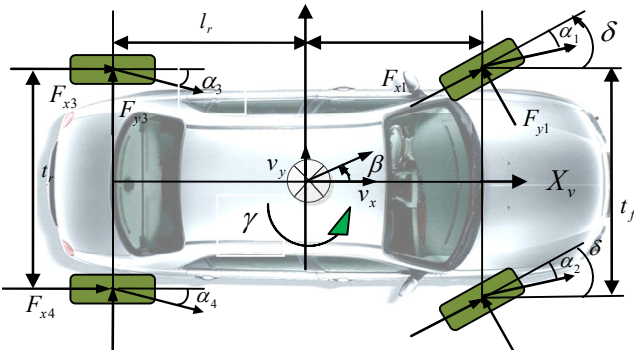

Fig.1. Eight DOF vehicle dynamic model.

$\sum F_{xi}$  are wheels longitudinal resultant forces ( $i = 1, 2, 3, 4$ ).  $\sum F_{yi}$  are wheels lateral resultant forces.  $Z_v$  is axis torque.  $m$  is vehicle mass and  $v_y$  are velocity components in  $X_v$  and  $Y_v$ .  $l_f$  and  $l_r$  are distances between centroid to front and rear axle.  $t_f$  and  $t_r$  are distances between front and rear wheel.  $\gamma$  and  $\dot{\gamma}$  are yaw velocity and yaw angular acceleration.  $I_x$  is the moment of inertia around  $X_v$  axle.  $I_z$  is the moment of inertia around  $Z_v$  axle.  $I_{xz}$  are the moment of inertia around  $X_v$  and  $Z_v$  axle.  $\omega_{wi}$  are wheel angular velocity ( $i = 1, 2, 3, 4$ ).  $I_{wi}$  are wheel moment of inertia ( $i = 1, 2, 3, 4$ ).  $R_w$  is wheel radius.  $T_{bi}$  are brake torque ( $i = 1, 2, 3, 4$ ).  $\delta$  is steering wheel angle.  $m_s$  are vehicle sprung mass.  $h_s$  is the vertical distance from spring centroid to the roll center.  $\phi$  is side angle.  $\Delta F_{x,eq}$  and  $k_{\phi r}$  are roll stiffness of front and rear suspension.  $c_{\phi f}$  and  $c_{\phi r}$  are the roll angle damping of front and rear suspension.

### B. Model of a multi-stage Kalman filter

Kalman filter is a kind of linear filtering recursive algorithm for discrete signal [19]. For a discrete system:

$$x(k) = A(k)x(k-1) + B(k)u(k-1) + w(k) \quad (10)$$

$$y(k) = H(k)x(k) + v(k) \quad (11)$$

$x(k)$  is the system state vector.  $y(k)$  is the system observation vector.  $u(k)$  is the system input vector.  $A(k)$  is the  $n \times n$  system state matrix.  $H(k)$  is the  $m \times n$  system observation matrix.  $B(k)$  is the  $1 \times n$  system input matrix.  $w(k)$  is the process noise vector.  $v(k)$  is the observation noise vector.

Assumptions and  $v(k)$  were independent, and the noise is normal distribution white noise, and  $v(k)$  is expressed as follows:

$$E[w(n)w^T(k)] = \begin{cases} Q(k) & n = k \\ 0 & n \neq k \end{cases} \quad (12)$$

$$E[v(n)v^T(k)] = \begin{cases} R(k) & n = k \\ 0 & n \neq k \end{cases} \quad (13)$$

$$E[w(n)v^T(k)] = 0 \quad (14)$$

Where  $Q(k)$  is noise covariance matrix, and  $R(k)$  is observation noise covariance matrix.

The first step of the Kalman filter is predicting the next state of the system. If system state is  $x(k)$ , then the next time system state is:

$$x(k+1|k) = Ax(k|k) + B(k)u(k) \quad (15)$$

The update status covariance matrix:

$$P(k+1|k) = A(k)P(k|k)A^T(k) + Q(k) \quad (16)$$

The state at  $k+1$  time is:

$$x(k+1|k+1) = x(k+1|k) + K_g(k)[y(k+1) - H(k)x(k+1|k)] \quad (17)$$

Where  $K_g(k)$  is Kalman gain:

$$K_g(k) = \frac{P(k+1|k)H^T(k)}{H(k)P(k+1|k)H^T(k) + R(k)} \quad (18)$$

$$P(k+1|k+1) = [I - K_g(k)H(k)]P(k+1|k) \quad (19)$$

Kalman filter estimation algorithm has five formulas. If giving initial value of state  $x(0)$  and state covariance matrix  $P(0)$ , the system state can gradually be estimated by the recursive method.

GPS and INS combination methods can be divided into kinematic method and dynamic method. Kinematic method is based on the motion relations of a car, and it does not rely on the estimation of vehicle dynamics model. Because there is no model error, measure accuracy depends on the accuracy of testing device and the installation position, so this method is very robust [16].

Vehicle sideslip angle fusion algorithm based on GPS/INS is shown in Fig.2. The main parameters in GPS measurement are heading angle  $\psi_{GPS}$ , azimuth angle  $\theta_{GPS}$  and speed  $v_{GPS}$ , and the main parameters of INS measurement are yaw rate  $\gamma_{gyro}$ , longitudinal acceleration  $a_{x,acc}$  and lateral acceleration  $a_{y,acc}$ .

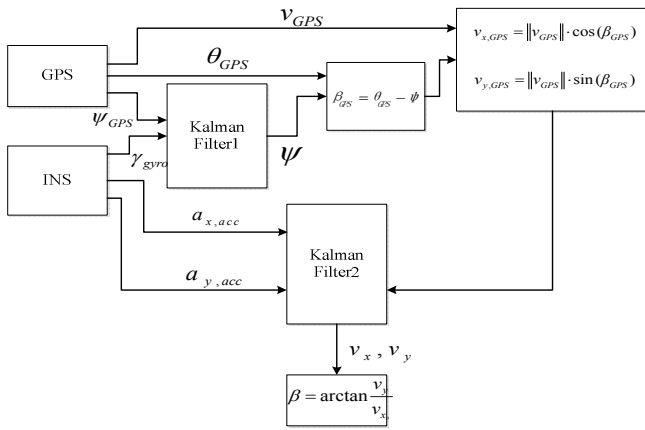

Fig.2. Sideslip angle combination algorithm block.

This work used a two-stage Kalman filter to fuse GPS and INS measurements. First, yaw rate measured by gyroscope and heading angle measured by double antenna GPS receiver are fused by Kalman filter 1. The output is vehicle course angle  $\psi$ . Longitudinal  $v_{x,GPS}$  and lateral  $v_{y,GPS}$  velocities are calculated according to the azimuth angle  $\theta_{GPS}$  and velocity course angle  $\psi$ . Second, the longitudinal  $a_{x,acc}$  and lateral  $a_{y,acc}$  acceleration measured by INS and the longitudinal  $v_{x,GPS}$  and lateral velocities  $v_{y,GPS}$  are fused by Kalman filter 2. The vehicle sideslip angle ratio can be obtained according to the vehicle sideslip angle  $\beta$ .

Compared to the conventional GPS/INS algorithm, the algorithm has some advantages: less state vector and computing times. Thus, the algorithm can meet the requirement for real-time vehicle stability control. When GPS signal is lost, inertial navigation system can calculate the vehicle sideslip angle. At the same time, inertial navigation system achieves the error correction with GPS information.

### C. Vehicle stability parameters calculation

Heading angle measured by dual antenna GPS receiver can be written as

$$\psi_{GPS} = \psi + w_{\psi}^{GPS} \quad (20)$$

$\psi_{GPS}$  is heading angle measured by GPS receiver.  $w_{\psi}^{GPS}$  is GPS observation noise.

Yaw rate measured by gyroscope can be written as:

$$\gamma_{gyro} = \dot{\psi} + \gamma_{\Delta} + w_{\gamma}^{gyro} \quad (21)$$

$\gamma_{gyro}$  is yaw rate measured by gyroscopes.  $\psi$  is heading angle.  $\gamma_{\Delta}$  is yaw velocity deviation.  $w_{\gamma}^{gyro}$  is the gyro noise (process noise).

The state equations of Kalman filter are written as follows:

$$\dot{x} = \begin{bmatrix} \dot{\psi} \\ \dot{\gamma}_{\Delta} \end{bmatrix} = \begin{bmatrix} 0 & -1 \\ 0 & 0 \end{bmatrix} \begin{bmatrix} \psi \\ \gamma_{\Delta} \end{bmatrix} + \begin{bmatrix} 1 \\ 0 \end{bmatrix} \gamma_{gyro} + \begin{bmatrix} w_{\psi}^{gyro} \\ 0 \end{bmatrix} \quad (22)$$

Observation equation is written as:

$$y = \psi_{GPS} = \begin{bmatrix} 1 & 0 \end{bmatrix} \begin{bmatrix} \psi \\ \gamma_{\Delta} \end{bmatrix} + \begin{bmatrix} w_{\psi}^{GPS} \\ 0 \end{bmatrix}$$

or  $y = \begin{bmatrix} 0 & 0 \end{bmatrix} \begin{bmatrix} \psi \\ \gamma_{\Delta} \end{bmatrix} + \begin{bmatrix} w_{\psi}^{GPS} \\ 0 \end{bmatrix} \quad (23)$

The state vector is  $[\psi \ \gamma_{\Delta}]^T$ , and the input is the yaw rate  $\gamma_{gyro}$  measured by a gyroscope. The observation value is the heading angle  $\psi_{GPS}$  measured by GPS. If GPS is available, the observation matrix C is [1 0]. If GPS is not available, the observation matrix C is [0 0].

1. GPS measurement of the vehicle longitudinal and lateral velocity

GPS measurement of the vehicle sideslip angle

$$\beta_{GPS} = \theta_{GPS} - \psi \quad (24)$$

$\beta_{GPS}$  is the sideslip angle measured by GPS and INS.  $\theta_{GPS}$  is the azimuth measured by GPS.  $\psi$  is the heading angle measured by GPS and INS.

GPS measurement of the vehicle longitudinal and lateral velocity (vehicle body coordinate) can be written as:

$$v_{x,GPS} = \|v_{GPS}\| \cdot \cos(\beta_{GPS}) \quad (25)$$

$$v_{y,GPS} = \|v_{GPS}\| \cdot \sin(\beta_{GPS}) \quad (26)$$

If the main antenna of GPS is installed at the vehicle centroid, longitudinal and lateral velocity can be written as:

$$v_{x,GPS} = v_x + w_x^{GPS} \quad (27)$$

$$v_{y,GPS} = v_y + w_y^{GPS} \quad (28)$$

2. Longitudinal and lateral velocity measured by acceleration sensor

$$a_{x,acc} = \dot{v}_x - \dot{\psi} \cdot v_y + a_{\Delta x} + w_{ax} \quad (29)$$

$$a_{y,acc} = \dot{v}_y - \dot{\psi} \cdot v_x + a_{\Delta y} + w_{ay} \quad (30)$$

$v_{GPS}$  is speed measured by GPS.  $v_{x,GPS}$  and  $v_{y,GPS}$  are longitudinal and lateral velocity components measured by GPS.  $v_x$  and  $\dot{v}_x$  are longitudinal velocity and longitudinal acceleration measured by sensor.  $v_y$  and  $\dot{v}_y$  are lateral velocity, lateral acceleration measured by sensor.  $a_{x,acc}$  and  $a_{y,acc}$  are longitudinal, lateral acceleration measured by acceleration sensor.  $a_{\Delta y}$  are longitudinal and lateral acceleration deviations.  $w_x^{GPS}$  and  $w_y^{GPS}$  are longitudinal and lateral GPS receiver noise.  $w_{ax}$  and  $w_{ay}$  are longitudinal and lateral acceleration sensor noise.

Kalman filter state equation:

$$\begin{bmatrix} \dot{v}_x \\ \dot{a}_{\Delta x} \\ \dot{v}_y \\ \dot{a}_{\Delta y} \end{bmatrix} = \begin{bmatrix} 0 & -1 & \dot{\psi} & 0 \\ 0 & 0 & 0 & 0 \\ -\dot{\psi} & 0 & 0 & -1 \\ 0 & 0 & 0 & 0 \end{bmatrix} \begin{bmatrix} v_x \\ a_{\Delta x} \\ v_y \\ a_{\Delta y} \end{bmatrix} + \begin{bmatrix} 1 & 0 \\ 0 & 0 \\ 0 & 1 \\ 0 & 0 \end{bmatrix} \begin{bmatrix} a_{x,acc} \\ a_{y,acc} \end{bmatrix} + \begin{bmatrix} -w_{ax} \\ 0 \\ -w_{ay} \\ 0 \end{bmatrix} \quad (31)$$

Where  $\dot{\psi} = \gamma_{gyro} - \gamma_b$

Kalman filter observation equation:

$$\begin{bmatrix} v_{x,GPS} \\ v_{y,GPS} \end{bmatrix} = \begin{bmatrix} 1 & 0 & 0 & 0 \\ 0 & 0 & 1 & 0 \end{bmatrix} \begin{bmatrix} v_x \\ a_{\Delta x} \\ v_y \\ a_{\Delta y} \end{bmatrix} + \begin{bmatrix} w_x^{GPS} \\ w_y^{GPS} \end{bmatrix} \quad (32)$$

$[v_x \ a_{\Delta x} \ v_y \ a_{\Delta y}]^T$  is state vector, and  $[v_{x,GPS} \ v_{y,GPS}]^T$  is observation values.

### 3. Vehicle sideslip angle calculation

Sideslip angle measured by GPS and INS is:

$$\beta = \arctan \frac{v_y}{v_x} \quad (33)$$

When GPS signal is lost, no measurement can be done for  $v_{x,GPS}$  and  $v_{y,GPS}$ . But,  $a_{x,acc}$  and  $a_{y,acc}$  can be measured by an INS sensor. Then the sideslip angle can be determined.

The sideslip angle measured by GPS is the sideslip angle of GPS antenna. Usually the sideslip angle of vehicle centroid and even the wheel sideslip angle are needed. As the sideslip angle of GPS antenna is transformed into the sideslip angle of any point at vehicle, there should be a speed increment which angular velocity changes.

$$V_p = V_A + \gamma \cdot R_{A/P} \quad (34)$$

$V_p$  is the speed at P point.  $V_A$  is the speed at main antenna of GPS.  $R_{A/P}$  is the distance from main antenna to P.  $\gamma$  is yaw rate.

The sideslip angle of the point P can be calculated by the following formula.

$$\beta_p = \tan^{-1} \left( \frac{(V_p)_y}{(V_p)_x} \right) \quad (35)$$

$(V_p)_x$  and  $(V_p)_y$  are the velocity components in the vehicle body coordinates.

### 4. SIMULATION AND APPLICATION

In this work, vehicle structure parameters are used for simulation shown in Table 1.

Table 1. Vehicle parameters table.

symbols	Meaning	value	symbols	Meaning	value
$m$	Vehicle mass	1704.7	$k_{\phi f}$	Front suspension roll stiffness	47298N·m/rad
$m_s$	Suspended mass	1526.9kg	$k_{\phi r}$	Rear suspension roll stiffness	37311N·m/rad
$l_f$	Distance from centroid to front axle	1.035m	$c_{\phi f}$	Front suspension roll damp	2823(N·m)/(rad/s)
$l_r$	Distance from centroid to rear axle	1.655m	$c_{\phi r}$	Rear suspension roll damp	2653(N·m)/(rad/s)
$t_f$	Distance between front wheels	1.535m	$I_{wi}$	Wheel inertia	0.99kg·m <sup>2</sup>
$t_r$	Distance between rear wheels	1.535m	$R_w$	Wheel radius	0.313m
$h_c$	Centroid height	0.542m	$k_{\phi f}$	Front wheel cornering stiffness	55095N/rad
$I_x$	Roll inertia	744.0kg·m <sup>2</sup>	$k_{\phi r}$	Rear wheel cornering stiffness	55095N/rad
$I_z$	Yaw inertia	3048.1kg·m <sup>2</sup>	$A$	Front windward area	1.8 m <sup>2</sup>

A. Simulation

The vehicle dynamics model is built using Carsim software. The double lane change conditions are selected. Double lane change simulation is more commonly used in a vehicle stability testing, and it is a working state for the simulation of vehicle overtaking and obstacle avoidance. Fig.3. is a double lane change simulation route map.  $m_1 = 60, B_1 = 3.5, S_1 = 60, m_2 = 60, B_2 = 3.5, S_2 = 40, m_3 = 60, B_3 = 3.5, S_3 = 60$  m. Then the steering wheel angle is shown as Fig.4., the vehicle dynamic response is analyzed. Assume that the speed is 120 km/h, the adhesion coefficients are 0.9 and 0.4, the parameters of simulation vehicle are shown in Table 1., and the simulation results are shown as the following Fig.5. to Fig.8.

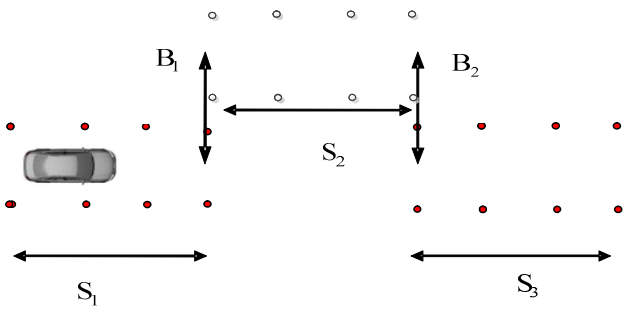

Fig.3. Double lane change simulation.

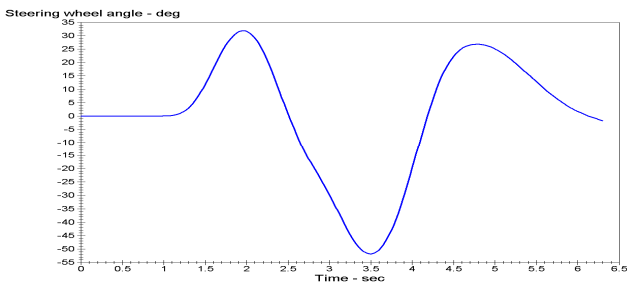

Fig.4. Steering wheel angle input curve.

Fig.5. and Fig.6. are yaw rate and sideslip angle curve, respectively when the adhesion coefficient is 0.9.

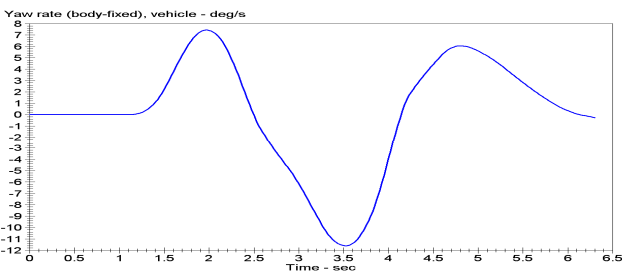

Fig.5. Yaw rate curve.

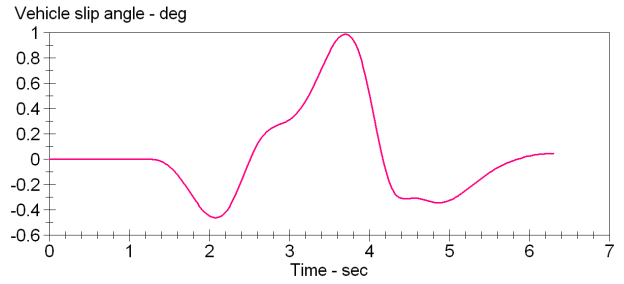

Fig.6. Sideslip angle curve.

Fig.7. and Fig.8. are the curves at the adhesion coefficient 0.4. Because the vehicle is on the low adhesion road surface and vehicle lateral force is the limit of lateral force, yaw rate and sideslip angle greatly deviate from the ideal value, and the vehicle is unstable.

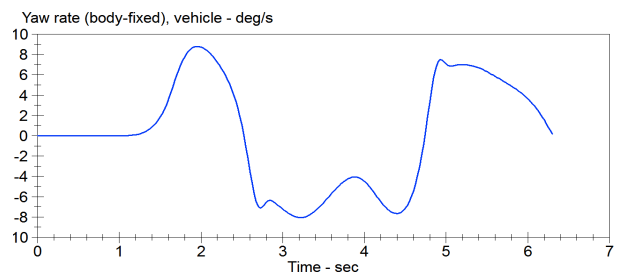

Fig.7. Yaw rate curve.

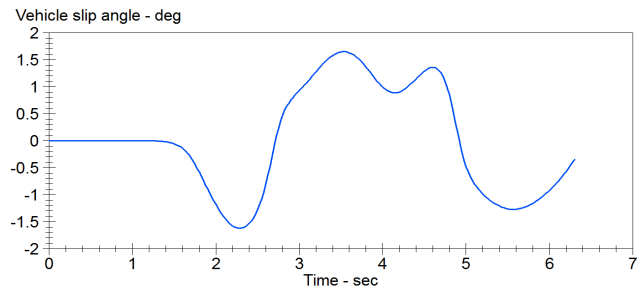

Fig.8. Sideslip angle curve.

The simulation experiment shows that the working condition is very dangerous when vehicle loses its stability. It is very difficult for a driver to keep vehicle stability when vehicle loses its stability. So it is necessary to evaluate the stability state of motion control system and other auxiliary means for the automobile control.

B. Experimental apparatus

1. GPS device

This paper uses HV2 dual antenna dual function GPS receiver. HV2 GPS receiver and antenna is shown in Fig.9., the receiver port and configuration is shown in Fig.10. and Table 2. HV2 can provide accurate directions, and the GPS positioning accuracy up to sub-meter level, 0.1 degrees heading precision and 20 Hz data update rate.

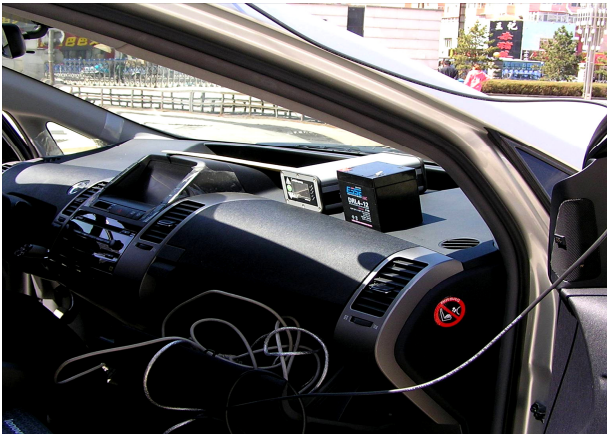

Fig.9. Crescent HV2 two antenna GPS receiver.



Fig.12. VG800 INS sensors.

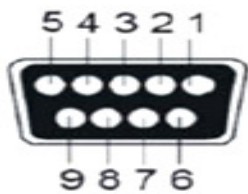

Fig.10. GPS receiver port.

Table 2. GPS receiver port setup.

Pin	signal	description
2	TXD	NMEA0183, binary, and RTC input
3	RXD	NMEA0183, binary, and RTC output
5	ground	signal return
6	input	event input

2. Inertial navigation system experiment device

The system uses the VG800 INS sensor which is made in MEMSIC Inc. The sensor terminal and the configuration are shown in Fig.11. and Table 3., and the shape is shown in Fig.12.

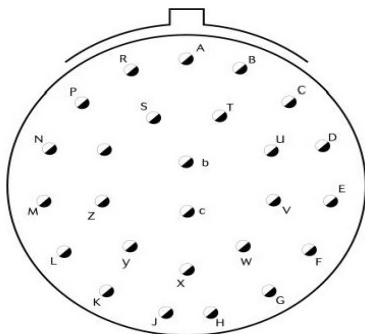

Fig.11. Sensor connector.

Table 3. Sensor connector setup.

Pin	Signal
A	RS-422 Transmit Data
B	RS-232 Transmit Data
E	Positive Power Input (+)
F	Ground
G	Analog Output X-Accel Voltage
H	Analog Output Y-Accel Voltage
J	Analog Output Z-Accel Voltage
K	Analog Output Roll Rate
L	Analog Output Pitch Rate
M	Analog Output Yaw Rate
N	Analog Output Roll Angle
P	Analog Output Pitch Angle
T	Reserved – factory use only
U	System Fault
W	Reserved – factory use only

3. Oxford RT3102 inertial and GPS navigation system

An Oxford RT3102 inertial and GPS navigation system instrument is used to verify to GPS and INS system measurement. RT3102 instrument is shown in Fig.13. It is Oxford Technical Solutions instrument for making precision measurements of motion in real-time. It can measure the vehicle longitudinal velocity, lateral velocity and sideslip angle. RT3102 instrument technology parameters are shown in Table 4.



Fig.13. Oxford RT3102 inertial and GPS navigation system.



Table 4. RT3102 technical parameters.

Position accuracy	0.6 m CEP
Velocity accuracy	0.1 km/h RMS
Heading	0.1°
Acceleration Bias	10 mm/s <sup>2</sup>
Angular rate	0.01 °/s
Update rate	100 Hz

4. Data acquisition device

In this paper an INDAS-5000 embedded system is the data acquisition system which is shown in Fig.14. INDAS-5000 is on a printed circuit board (PCB) integrated real-time embedded processor, field programmable gate array (FPGA), and analog and digital I/O.



Fig.14. Data acquisition system.

C. Measurement experiment

The single lane experimental conditions are selected to measure the vehicle sideslip angle. Single lane experiment is more commonly used in a vehicle stability testing. And it is a working state for the simulation of vehicle overtaking and obstacle avoidance. Fig.15. is a single lane experimental route map. Similarly, high adhesion and low adhesion road experiment should be carried out.  $m, S_1 = 50, S_1 = 50$  m,  $S_2 = 30, S_2 = 30$  m.

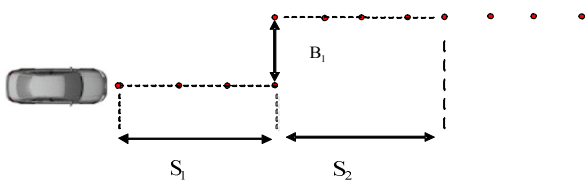

Fig.15. Single change test road.

Dual antenna receiver can directly measure the vehicle sideslip angle. The dual antenna GPS receiver measures vehicle centroid heading angle (Fig.16.) and the centroid azimuth (Fig.17.), the difference between the heading angle and the centroid azimuth is the sideslip angle (Fig.18.). The vehicle sideslip angle measured by GPS/INS, which is fused by a two-stage Kalman filter, is shown in Fig.19. From Fig.19., it can be seen that the vehicle sideslip angle is smooth after the Kalman filter algorithm. In Fig.20., the vehicle sideslip angle, which is measured by 3102 sensor, calibrates the sideslip angle measured by GPS/INS. The curves are very similar.

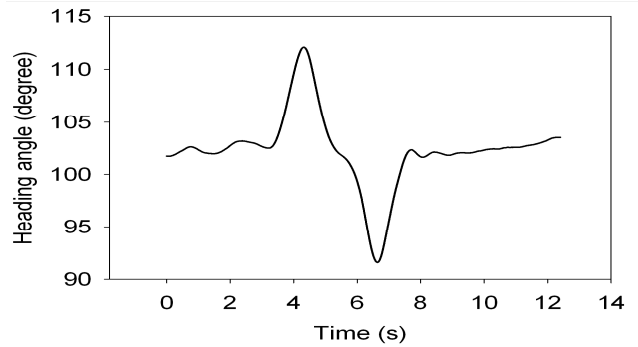

Fig.16. Heading angle curve.

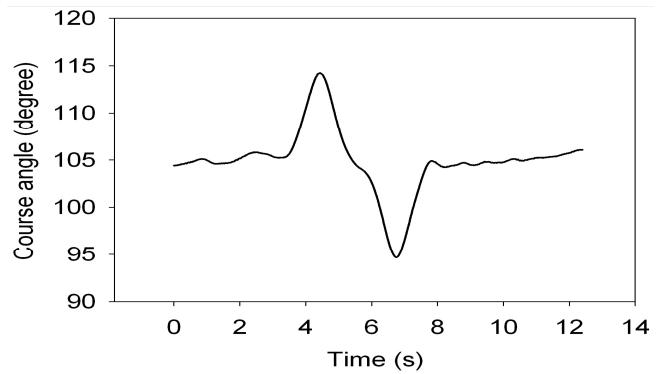

Fig.17. Course angle curve.

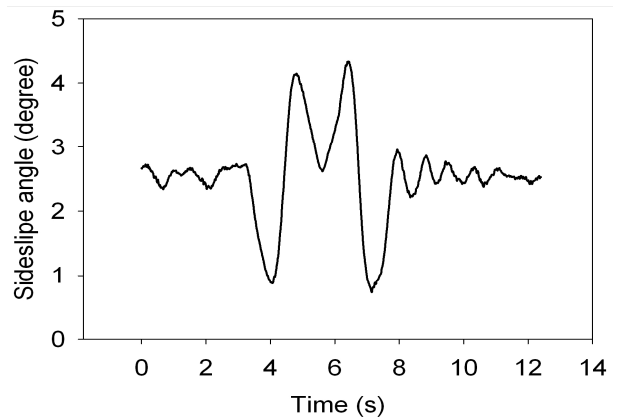

Fig.18. Sideslip angle curve.

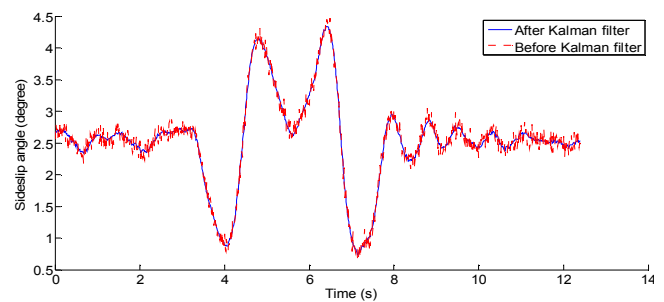

Fig.19. Sideslip angle curve.



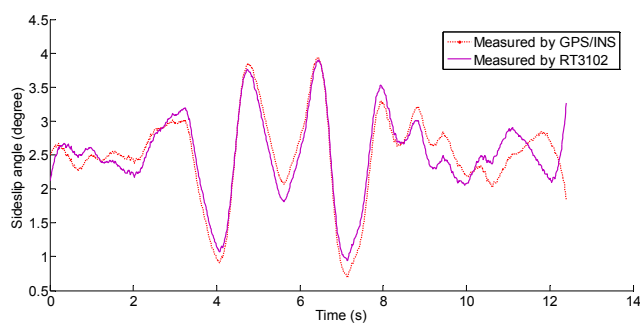

Fig.20. Sideslip angle curve measured by RT3102 sensor.

From the experimental data, it can be seen that the use of vehicle dynamics model and Kalman filter algorithm, especially the two-stage Kalman filter, is a good solution for the problem of GPS signal loss and INS signal accumulation error increase during vehicle stability testing. This method meets well the real-time and accuracy requirements for measurement of the vehicle stability key parameters.

### 5. CONCLUSION

Acquisition of vehicle driving state parameters, which vehicle stability control required, is the premise and key technology of the vehicle stability control. In response to the need for vehicle stability critical state parameters testing, the real-time and accuracy is the goal. In addition, adaptive method, error compensation technology, statistical characteristic and noise filtering are subjects in data fusion for future research. This paper presents a robust method for vehicle stability testing based on GPS/INS. Based on the GPS velocity measurement technique, a robust method of sideslip angle, speed and vehicle state parameters measurement and estimation is proposed. Using the integration of GPS and INS information, which are fused by the two-stage Kalman filter, solves the problem of GPS signal loss and low update rate. The RT3102 instrument is used to verify the effect of GPS/INS measurement and estimation of vehicle state parameters under typical driving condition. The experimental results showed that the method of GPS and INS measurement for vehicle stability key parameters is accurate and real-time, and this method can meet the test and design requirements of vehicle stability controller.

### ACKNOWLEDGMENT

The Department of Education of Heilongjiang and China Association for Science and Technology provided the financial support of this work. This work is supported by the Research Projects under the Department of Education of Heilongjiang Grant No.:12511453 and Overseas Research and Development Program under Grant No.:10027.

### REFERENCES

- [1] Yi, K., Chung, T., Kim, J., Yi, S. (2003). An investigation into differential braking strategies for vehicle stability control. *Journal of Automobile Engineering*, 217 (12), 1081-1093.
- [2] Miao, Z.B., Zhang, H.T. (2013). Vehicle stability testing using the dewetron test system. *Electronics World*, 119 (1927), 24-26.
- [3] Sugiyama, M., Inoue, H., Uchida, K., Monzaki, S., Inagaki, S., Kido, S. (1997). Development of VSC (vehicle stability control) system. *TOYOTA Technical Review*, 46 (2), 61-68.
- [4] Nakazawa, M., Isobe, O., Takahashi, S., Wanatabe, Y. (1995). Braking force distribution control for improved vehicle dynamics and brake performance. *Vehicle System Dynamics*, 24 (4-5), 413-426.
- [5] Wallner, E., Schiffmann, J. (2000). *Development of an automotive rollover sensor*. SAE Technical Paper 2000-01-1651.
- [6] Yoon, J., Yi, K. (2006). A rollover mitigation control scheme based on rollover index. In *American Control Conference 2006*, 14-16 June 2006. IEEE, 163-179.
- [7] Yoon, J., Cho, W., Koo, B., Yi, K. (2009). Unified chassis control for rollover prevention and lateral stability. *IEEE Transactions on Vehicular Technology*, 58 (2), 596-609.
- [8] Cho, Y., Kwak, B. (2007). *A control and analysis of vehicle rollover based on electronic stability control*. SAE Technical Paper 2007-01-3566.
- [9] Solmaz, S., Corless, M., Shorten, R. (2007). A methodology for the design of robust rollover prevention controllers for automotive vehicles with active steering. *International Journal of Control*, 80 (11), 1763-1779.
- [10] Jun, L. (2006). *Research and simulation of vehicle stability control strategy*. Thesis, Wuhan University of Science and Technology, China.
- [11] Huang, D.Y., Chen, C.H., Hu, W.C., Yi, S.C., Lin, Y.F. (2012). Feature-based vehicle flow analysis and measurement for a real-time traffic surveillance system. *Journal of Information Hiding and Multimedia Signal Processing*, 3 (3), 282-296.
- [12] Pan, J.S., Ma, S., Chen, S.H., Yang, C.S. (2015). Vision-based vehicle forward collision warning system using optical flow algorithm. *Journal of Information Hiding and Multimedia Signal Processing*, 6 (5), 1029-1042.
- [13] Yang, F., Li, Y., Ku, H., Rong, X., Song, R. (2010). Attached to real-time estimation of coefficient of extended state observer based on the pavement. *Journal of Agricultural Machinery*, 41 (8), 6-9.
- [14] Yu, M., Qian, L. (2005). Vehicle movement measurement based on RTK five wheels. *Automotive Engineering*, 27 (1), 54-56.
- [15] Zhang, S. (2006) *Research on algorithm for vehicle state testing system based on INS and GPS*. Thesis, Jilin University, China.
- [16] Jiang, H. (2008). *Dynamic performance test of automobile based on GPS and gyro*. Thesis, Xihua University, China.
- [17] Rock, K.L., Beiker, S.A., Laws, S., Gerdes, J.C. (2005). Validating GPS based measurements for vehicle control. In *ASME 2005 : Dynamic Systems and Control Division*, 5-11 November 2005. ASME, 583-592.

- [18] Bevly, D.M., Gerdes, J.C., Wilson, C., Zhang, G. (2000). Use of GPS based velocity measurements for improved vehicle state estimate. In *American Control Conference*, 28-30 June 2000. IEEE, Vol. 4, 2538-2542.
- [19] Chung, T., Yi, K. (2006). Design and evaluation of side slip angle-based vehicle stability control scheme on a virtual test track. *IEEE Transactions on Control Systems Technology*, 14 (2), 224-234.
- [20] Ryn, J. (2004). *State and parameter estimation for vehicle dynamic control using GPS*. Thesis, Stanford University, CA.
- [21] Zhang, J.Z. (2012). *Study on vehicle stability control system based on GPS*. Thesis, Harbin Engineering University, China.

Received February 10, 2015.  
Accepted December 1, 2015.