

Measurement of the Operating Parameters and Numerical Analysis of the Mechanical Subsystem

Pavol Božek¹, Yuri Turygin²

¹Institute of Applied Informatics, Automation and Mathematics, Faculty of Materials Science and Technology
Slovak University of Technology, Hajdóczyho 1, 917 24 Trnava, Slovakia, pavol.bozek@stuba.sk

²Department of Mechatronic Systems, Izhevsk state technical university, Izhevsk, Russia, asp@istu.ru

Submission is focused on completing the information system about quality, operation, automatic testing and new evaluating method of vehicle subsystem. Numeric analysis is carried out on the base of automatic collection and systematic recording of commercial car operation. Proposed new information system about operation and trial process allows verification according to the proposed method. Critical components verified in laboratory conditions are detected by numeric analysis of reliability. Quality level increasing not only for final product, but also related automatic test laboratory for cars is the result of respecting these principles.

Keywords: Measuring information, trial automation, new methodology.

1. INTRODUCTION

TENDENCY TO ensure high technical and operational parameters of a car, and consequently successful realisation of any difficult technical system and mechanism comes out from perfect knowledge of operational conditions, knowledge of operation – technical characteristics and parameters of the system as such. This fact requires increasing requests for technical level of measurement, actual time of measurement results, precision of measurement results, possibility of measurement result processing, level of measurement automation, i.e. measurement as method of objective quantification of physical values, or about relation between two or more physical values. Analysis of achieved results from dealing with the car security area in whole scale of connectivity and relations confirms that the role of laboratory verification is not replaceable in new quality management system. The overall approach to the issue of the test questions in new quality management system, persistent in car production concept, is getting necessary and the car production process as well as the analysis of development trends in car industry shows, the solution to automated testing has an objective need [4], [8].

It is necessary to be concerned about automation data gathering about component operation mode in real conditions. It is possible to define their reliability based on gathered data about operating and component failure accepting. It is possible to design a device for test tracing of components and a test method after defining critical elements.

We gather data about component operation this way, as the difficult system is in accordance with science and development principles, thus, preventing un-controlled production of non-verified elements in industrial production [6]. Based on gathered data, it is possible to increase component reliability and to reach a higher level in planned car production.

2. GEARBOX QUALITY PROBLEM

Current dynamic development of car industry, continuously increasing level of their technical parameters and characteristics confirms continually the whole process speeding competition in the world.

Using the gearbox as a car decisive component is limited also by complex access level to quality assurance. It is possible to carry out gearbox general function model and its accuracy analysis based on present ways of functional unit and devices accuracy. General accuracy of function units is understood as quality of approach function and operational dependencies, acted in mechanisms to request dependencies for which these function units were constructed and chosen [7].

From the point view of gearbox utility, i.e. gearbox using and ability, general criteria are its quality and its basic intention, divided into:

- *manipulation ability*, if we evaluate it in aspect of control and manipulation with gearbox within speed striking,
- *technologic ability*, if gearbox is evaluated in aspect of use in car as means of realisation of chosen drive kind.

A. Problems with quality management.

Today brings significant changes in product area, in all industrial countries. Understanding of changes in quality is possible to characterise as a movement from clearly technical soundness to integral product quality [5]. Product quality became a significant criterion of science and research effect and big productivity reserve of common work.

This general definition of development in quality field and objective need to continually increase quality in application for cars, which reports to increasing requirements for high technical and operating parameters, requires:

- systematic directing of all related actions, i.e. arrange questions of quality management to the whole gearbox building process,

- complex evaluation of quality, which requires the use of quantitative evaluation,
- identification of quality, i.e. to evaluate the achieved quality level, which has basic importance to control the whole creating process and gearbox innovation process,
- comparison of objective gearbox parameters with comparable world level types directly by measuring chosen parameters, or indirectly by data from progressive technical information.

Quality management is perceived as complex, if it is expanded to all fields, which can influence the final gearbox quality, including user's operation. This system, which dominates today in all industrial countries, creates conditions in flow pre-production, production and after production activities by using objective methods for applied testing [2].

B. Analysis of reliability influence to profitability and economic effect.

Before analysis of gearbox reliability influence to economic effect, it is important to realise basic ideas of reliability theory and to check relation of coefficients quantitative reliability to economic coefficient and efficiency coefficient. Related basic ideas:

Quality of product is the summary of properties, expressing ability to fulfil functions, to which it is dedicated. We take into account also product economic coefficients, its outfit by accessories, spare parts, etc., as well as premises, which the producer creates to provide services connected to product use.

Reliability is general object attribute, reposing in ability to fulfil requested functions while keeping values for specified operational coefficients in specified limits and in time according to technical conditions. Reliability is one of the most important groups of product quality marks.

3. METROLOGICAL ASSURANCE OF AUTOMATION TESTING

From the point view of measuring accuracy technics for test managing mechanism, it is necessary to see, that measuring technical assurance is realised mostly on principles of electrical measuring of non-electrical values with appropriate automation measuring process level and evaluating process. This concept of automatic measuring systems creation is not secured very well in the metrological way yet [3]. This field significantly documents the current status, advance of technical practice before readiness of metrological assurance. That is why it is possible to define requirements needed for metrological assurance at least of individual parts of the automation measuring system, i.e. individual measuring strings used in measuring and tests.

A. Measuring string structures.

Measuring string – device sets intended for measuring, transport and data processing of the measured value in general form represent the sensor set, measures, measuring instrument, converters, measuring channels, analogue and numeric technical devices, computing devices, sensors and registered devices attached to one function unit in order to requested measuring, processing of data about the measured

parameters. A general measuring string block schema is shown in Fig.1.

It is possible to characterise measuring string individual blocks in the way of functions by this description:

1. input block – is created by sensor sets, which scan required measured parameters, ensure data entrance to measuring string.
2. block of converters – ensures data processing from entrance block to suitable form for the following processing, mostly to the numeric form.
3. pre-processing block – is used to data pre-processing (check, filtration etc.)
4. processing block – ensures data processing by specified algorithm, it is composed of suitable computing devices including a particular software.

Output block – ensures data output in required form [3]. Printers, recorders, control panels, etc. belong here. Following is a memory device, where it is possible to store obtained data for further processing.

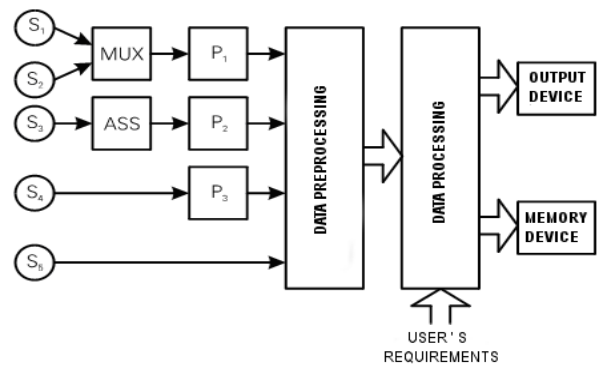

Fig.1. Measuring string block scheme

S₁ ... S₅ – sensors; MUX – measuring switchers, multiplexer; P₁ ... P₃ – analogue-numeric converters, ASS – analogue executing system.

Measuring string does not have to contain all involved parts; it is possible to drop some of them, or expire some parts and to complete the measurements according to requirements of concrete application [1].

B. Further component results from car under operation.

Numbers of several speed degree exploitations are written in Table 1. After mathematic counting of individual speed strikes, coefficient of exploitation has been stated for individual speed as well as for the whole gear system. To emphasize the difference, measuring results of both modes are drawn to one in Fig.2. This result proves arguments of earlier car abrasion in city traffic. Values are specified. After summarizing measuring results, it is possible to express also gear mechanism use in per cent. Results are in Fig.2.

4. TECHNICAL MEANS OF AUTOMATION TEST SYSTEM

The role of technical devices is becoming important in accordance with increasing technical level of developed devices and with motoring research trends, as well as with high requirements and method severity of their testing and evaluation.

Table 1. Control mechanism and speed degrees of 5 speed degrees gearbox use.

Geared speed degree	Number of gear n	use [%]	coefficient f_j [%]
1	97555	20.4	8.49
2	114100	23.8	12.44
3	154050	32.1	26.06
4	91300	19.1	36.70
5	18805	3.9	15.80
R	3350	0.7	0.47
TOTAL	479160	100.0	100.00

Technical assurance of car components measuring, i.e. difficult devices must fulfil these limits and conditions:

- tests of technical severity on a moving car without enough space to install measuring and testing equipment to the car require the application of measure signal remote transmission on analogue or discrete signal level, analysis provides following data perfect overview and is used as a base for the team of development designers.
- it is necessary to measure mechanical values by transformation of physical parameters to electrical signal, i.e. with the measuring method of no electrical values by electrical way. It is necessary to correct signal from sensor and store it so that it is available for direct processing, or for analysis,
- test system must be able to function automatically, i.e. automatic scanning of measured values, their processing, storing and editing in suitable form for further use,
- in test realisation, there must be connectivity between gear mechanism movement and measuring system control, that means test system must be automatic and connected to test cycle managing via control inputs of gear mechanism.

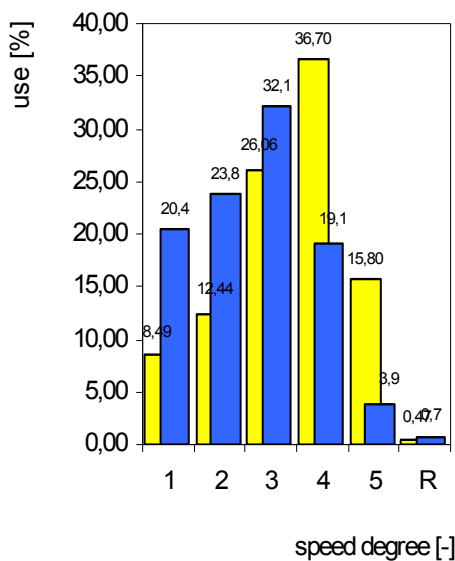

Fig. 2. Control mechanism total use.

A. Configuration of automatic test system devices and their connection.

As a result of present possibilities and the most necessary needs, configuration for ATS, which is drawn in Fig.3., was proposed. Individual measuring equipment and control devices are connected to the control system by system bus, which fulfils requirements for adaptability of device configuration for individual measuring and testing tasks and for eventual configuration expansion [6].

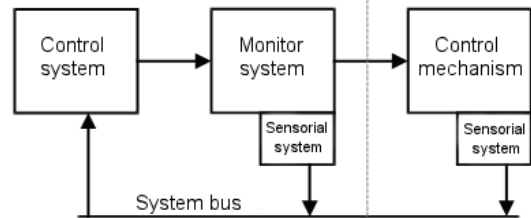

Fig. 3. Block schema devices ASS.

B. Automatic test system project.

It is possible to create concrete project solution of automated test system accepting results obtained by now, according to Fig.4.

As it comes out from gear mechanism test conditions, flyer system, evolve controller and starting clutch connection is not needed.

These parameters are necessary to take into account in speed degree gear (related to handle gear arm). This is test in laboratory conditions:

- 1) control power of default $F_p = 50$ N
- 2) control power of gear $F_r = 70$ N
- 3) path length by default $l_p = 30$ mm
- 4) path length by operation $l_R = 55$ mm
- 5) time of default $s_p = 1$ sec
operate of gear $s_R = 1$ sec

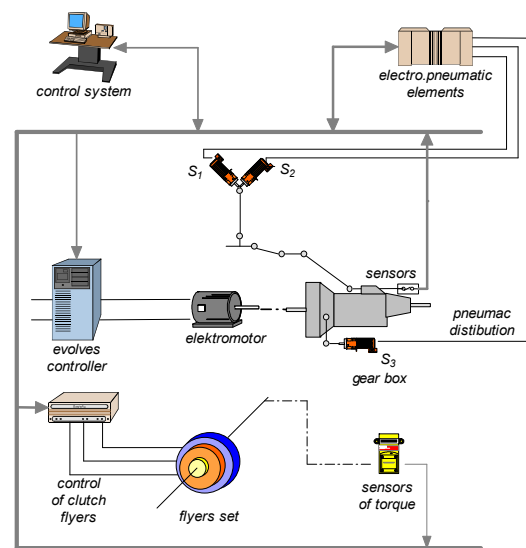

Fig. 4. Insertion ASS schema.

Pneumatic rollers S_1 and S_2 do the speed gearing process. Double acting pneumatic roller S_1 assures pre-selection of speed degrees directly at gear arm and double acting pneumatic roller S_2 assures speed degrees gearing.

C. Motive system acts description.

Algorithm of charging whole gear control mechanism is specified by pneumatic roller synchronisation. One trial cycle is given in Table 2. The results of speed degrees gear process – Fig.5. This material is base for control system programming.

Gear mechanism trial process depends on its used level. The base of test is to repeat the speed degree gear process. From speed degree 1 to speed degree 5 and the other way around from speed degree 5 to speed degree 1. Concrete algorithm of test pass includes methodology part.

Table 2. Pneumatic roller synchronization.

Number of step	Description	Roller S_1	Roller S_2
	<i>ACCELERATION MODE</i>		
1.	Roller 1. default 1. speed degree	✓	
2.	Roller 2. gear 1. speed degree		✓
3.	Roller 2. moves gearbox to neutral position		✓
4.	Roller 2. gear 2 speed		✓
5.	Roller 2. moves gearbox to neutral position		✓
6.	Roller 1. moves gearbox to neutral position	✓	
7.	Roller 2. gear 3 speed degree		✓
8.	Roller 2. moves gearbox to neutral position		✓
9.	Roller 2. gear 4 speed degree		✓
10.	Roller 2. moves gearbox to neutral position		✓
11.	Roller 1. defaults 5 speed	✓	
12.	Roller 2. gear 5 speed degree		✓

Number of step	Description	Roller S_1	Roller S_2
	<i>DECELERATION MODE</i>		
13.	Roller 2. moves gearbox to neutral position		✓
14.	Roller 1. moves gearbox to neutral position	✓	
15.	Roller 2. gear 4 speed degree		✓
16.	Roller 2. moves gearbox to neutral position		✓
17.	Roller 2. gear 3 speed degree		✓
18.	Roller 2. moves gearbox to neutral position		✓
19.	Roller 1. default 2 speed degree	✓	
20.	Roller 2. gear 2 speed degree		✓
21.	Roller 2. moves gearbox to neutral position		✓
22.	Roller 2. gear 1 speed degree		✓
23.	Roller 2. moves gearbox to neutral position		✓
24.	Roller 1. moves gearbox to neutral position	✓	

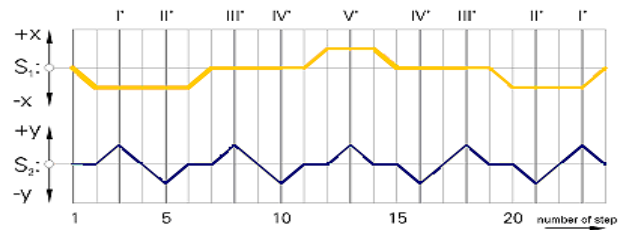

Fig.5. Insertion ASS schema.

5. RESULTS

RELIABILITY TRIALS METHOD PROPOSAL

Automated reliability verifying and gear mechanism life cycle is the test goal.

It is necessary to change dimensions, eventually construction nodes of least reliable elements before the test. Test methodology is deduced from the way of speed degree gearing during car running. Speed degrees gearing flow was introduced in the previous part. The flow repeats always the same way with aspect to chosen speed degree.

It is necessary to assure handle control power, path length of default and path length of speed degree gear. Gear mechanism lines effort by power intensity, which is prescript in tolerances during car running and followed construction nodes, to ensure fulfilment of these conditions.

Whole system is specified to follow up gear mechanism in aspect of car reliability during car running. From Table 1. it is deduced that in aspect of number speed degree gears the most used is speed degree 3 (32.1 %), and (26.06 %) in short path. Speed degree 4 is geared in small number (19.1 %), but it is geared on longer path (36.70 %). It is not possible to follow this reality in one aspect, because:

- a) if we want to follow results in aspect of number of gears, than it is in gear mechanism field
- b) if we want to see and follow the parameters change in aspect of gear length, than problem elements are gear-wheel, winches and their installing in gearbox.

The test method for control mechanism use in aspect of number of individual speed gears is proposed based on commerce car test measuring results. Deducing from Table 1., Fig.2. shows the ratio of gear mechanism use. This ratio must be kept during test and gear mechanism test in number, what is used and recorded in tables. Proposed ratio method seems to be the most suitable.

A. Ratio method.

Ratio method comes from distribution of percentage ratio elements use of gear mechanism during speed degrees gearing. Values of use from Table 1. are the base of distribution. Maximum level is reached when each component of gear mechanism is running by distribution in Table 1. during follow-up. Mathematic interpretation of number of gears z_u in one level and trial process is:

$$z_u = \frac{1}{u} \times \left[\sum_{i=1}^n n_{1i} + \sum_{i=1}^n n_{2i} + \sum_{i=1}^n n_{3i} + \sum_{i=1}^n n_{4i} + \sum_{i=1}^n n_{5i} \right] \quad (1)$$

Where:

- $n_1 - n_5 \dots$ number of gear in u -level
- $u \dots$ dividing level of max. number of gear
- $z_{1i} - z_{5i} \dots$ number of gear of individual speed degrees
- $n \dots$ maximum number of speed degrees gear of related speed

Example: if we want to follow-up gear mechanism element reliability in speed degree 5, then number of individual speed degree gears will be:

- $n_1 = 97555 / 5 = 19511$ times
- $n_2 = 114100 / 5 = 22820$ time
- $n_3 = 154050 / 5 = 30810$ time
- $n_4 = 91300 / 5 = 18260$ time
- $n_5 = 18805 / 5 = 3761$ times

Ratio method data are in Fig.6.

Use of coefficient estimate exactness or gear mechanism element reliability is higher, when the dividing level is higher. It is important to know that the same number of gears ratio in every level is kept in the ratio method.

We can see in Fig.6., that there is an area at the bottom, which is showing ratio number of gears of speed degrees of one level. Level 5 has 5 times smaller number of gears in the same ratio as the basic level. It is possible to fill this area by trial in 2 ways:

1. vertical classification,
2. horizontal classification.

B. Vertical classification.

The level of test according to vertical classification is divided in sequence according to speed percentage use. It means that control program gives command to gear speed degree 5 and then 4, 1, 2, and 3 as the last one. It is because all gear mechanism elements would be a follow-up from the speed degree which use is the smallest.

We have the biggest chance to verify the largest number of gear mechanism elements. We can see logical flow of gear mechanism test in the graph.

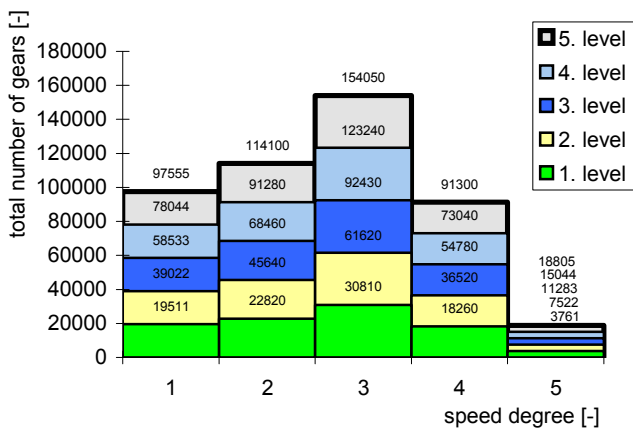

Fig.6. Testing according to ratio method by 5 levels.

Mathematic total number of gears z_{uV} in vertical classification is expressed by relation:

$$z_{uV} = u \times \left[\sum_{j=1}^{n_5} z_{5j} + \sum_{j=1}^{n_4} z_{4j} + \sum_{j=1}^{n_3} z_{3j} + \sum_{j=1}^{n_2} z_{2j} + \sum_{j=1}^{n_1} z_{1j} \right] \quad (2)$$

Where:

- $n_1 - n_5 \dots$ number of gear in u -level
 - $u \dots$ dividing level of max. number of gear
 - $z_{1i} - z_{5i} \dots$ number of gear of individual speed degrees
- Vertical classification is risky, because rest parts of gear mechanism will stay untested, for example, by testing speed degree 4 by failure.

This is a negative trial solution I according to horizontal classification.

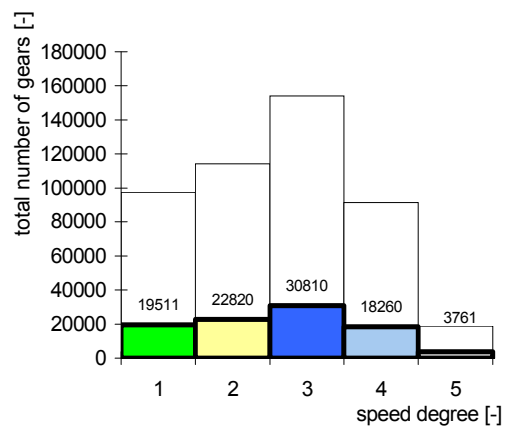

Fig.7. Level of test according to vertical classification.

C. Horizontal classification.

The test of gear mechanism elements by horizontal classification is steady according to Fig.8. All speed degrees gearing are in phase one.

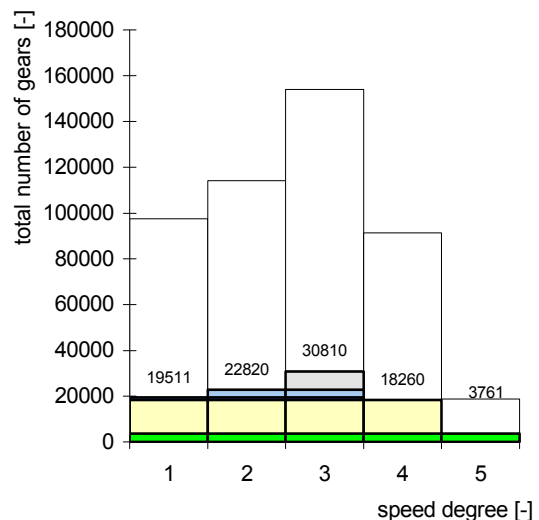

Fig.8. Level of test according to horizontal classification.

After that, control system gives command to test control mechanism from speed degree 4. Test till speed degree 3 is conducted the same way. It is gear separately from neutral position. We can mathematically interpret the number of gears Z_{uH} by horizontal classification test as follows:

$$Z_{uH} = u \times \left[Z_u - \sum_{j=1}^{n_5} Z_{5j} - \sum_{j=1}^{n_4} Z_{4j} - \sum_{j=1}^{n_1} Z_{1j} - \sum_{j=1}^{n_2} Z_{2j} - \sum_{j=1}^{n_3} Z_{3j} \right] \quad (3)$$

Where:

$n_1 - n_5$... number of gear in u-level

u ... dividing level of max. number of gear

$z_{1i} - z_{5i}$... number of gear of individual speed degrees

Cycle is repeated after one level of test is finished according to the proposed method.

6. DISCUSSION

The base for evaluation, formulation and parameters assurance of technical level, running quality and car reliability or its components, is knowledge of their technical and running parameters and running conditions. It is important to know the operating mode, dynamic stress, the way of operating and use during running.

Quality requirements are increasing also requirements for functional model laboratory testing, their parts, prototypes and their new components. This comes out of facts.

Practise in foreign countries showed, and it should be advice for us, that it is profitable to apply car problem parts to development and research. This submission focuses on increasing the quality level not only of the final product, but also the developing time by car automation test and its technical accessories.

ACKNOWLEDGEMENT

The reported study has been made within the framework of research project "Development of intelligent control and diagnostic systems of mechatronic drives" (2014-2016, registration number № 114030440070) with financial support from the Ministry of Education and Science of the Russian Federation

and project agency VEGA in the frame of the project 1/0432/14 „The development of the new robot control system based on hybrid sensors“ and project KEGA 003STU-4/2012 „Elaboration of interactive multimedia textbook of Mechatronics for secondary vocational schools“.

REFERENCES

- [1] Israeli, Y.Y., Ceder, A. (1995). Transit route design using scheduling and multiobjective programming techniques. In *Computer-Aided Transit Scheduling*, Lecture Notes in Economics and Mathematical Systems, Volume 430. Springer, 56-75.
- [2] Ngamchai, S., Lovell, D.J. (2000). Optimal time transfer in bus transit route network design using a genetic algorithm. In *Computer-Aided Scheduling of Public Transport : 8th Conference*, 21-23 June 2000, Berlin, Germany.
- [3] Páleník, T., Hart'anský, R. (2010). Numerical impedance analysis of thin wire dipoles. In *Mechatronika 2010 : 13th International Conference on Mechatronics*, 2-4 June 2010. IEEE, 51-53.
- [4] Gruttner, E., Pinnerhoff, M.A., Tudela, A., Díaz, H. (2002). Recorridos optimos de líneas de transporte público usando algoritmos genéticos. In *Jornadas Chilenas de Computación (JCC'2002)*, November 2002, Copiapo, Chile.
- [5] Slížik, J., Hart'anský, R. (2013). Metrology of electromagnetic intensity measurement in near field. *Quality Innovation Prosperity*, 17 (1), 57-66.
- [6] Černecký, J., Pivarčiová, E. (2007). *Possibilities and Prospects of Holography*. Izhevsk, Russia : State Technical University. ISBN 978-5-7526-0303-7.
- [7] European Committee Standardization (CEN) (2005). *Reference Data Model For Public Transport*, TC278.
- [8] Trebuňa, F., Maslákova, K., Frankovský, P. (2011). Residual stress measurements. In *Modelling of Mechanical and Mechatronic Systems 2011 : 4th International Conference*, 20-22 September 2011. Technical University Kosice, 487-491.

Received March 10, 2014.
Accepted August 14, 2014.